



Environment Monitoring Sensor

Featuring LoRaWAN[®]

EM300 Series

User Guide



Applicability

This guide is applicable to EM300 series sensors shown as follows, except where otherwise indicated.

Model	Description
EM300-TH	Temperature and Humidity Sensor
EM300-MCS	Magnet Switch Sensor
EM300-SLD	Spot Leak Detection Sensor
EM300-ZLD	Zone Leak Detection Sensor

Safety Precautions

Milesight will not shoulder responsibility for any loss or damage resulting from not following the instructions of this operating guide.

- ❖ The device must not be disassembled or remodeled in any way.
- ❖ In order to protect the security of the device, please change device password when first configuration. The default password is 123456.
- ❖ The device is not intended to be used as a reference sensor, and Milesight will not should responsibility for any damage which may result from inaccurate readings.
- ❖ Do not place the device close to objects with naked flames.
- ❖ Do not place the device where the temperature is below/above the operating range.
- ❖ Make sure electronic components do not drop out of the enclosure while opening.
- ❖ When installing the battery, please install it accurately, and do not install the reverse or wrong model.
- ❖ Make sure both batteries are newest when install, or battery life will be reduced.
- ❖ The device must never be subjected to shocks or impacts.

Declaration of Conformity

EM300 series is in conformity with the essential requirements and other relevant provisions of the CE, FCC, and RoHS.

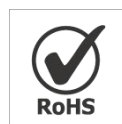

Copyright © 2011-2022 Milesight. All rights reserved.

All information in this guide is protected by copyright law. Whereby, no organization or individual shall copy or reproduce the whole or part of this user guide by any means without written authorization from Xiamen Milesight IoT Co., Ltd.

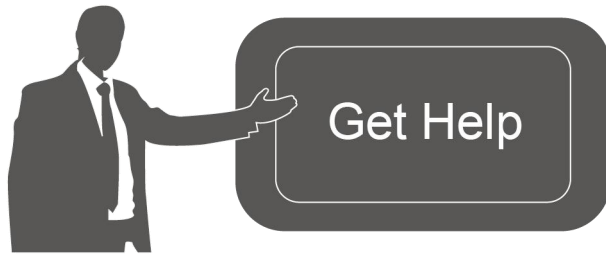

For assistance, please contact

Milesight technical support:

Email: iot.support@milesight.com

Tel: 86-592-5085280

Fax: 86-592-5023065

Address: Building C09, Software Park III,
Xiamen 361024, China

Revision History

Date	Doc Version	Description
Oct. 14, 2020	V 1.0	Initial version
Oct. 21, 2020	V 1.1	Model name change and pictures replace
Nov. 19, 2020	V 2.0	Layout replace
Mar. 4, 2021	V 2.1	Layout update
July 5, 2021	V 2.2	Delete USB Type-C description
Dec. 7, 2021	V 2.3	Add alarm setting, change SN to 16 digits

Contents

1. Product Introduction.....	5
1.1 Overview.....	5
1.2 Features.....	5
2. Hardware Introduction.....	5
2.1 Packing List.....	5
2.2 Hardware Overview.....	6
2.3 Dimensions.....	6
2.4 Power Button.....	6
3. Operation Guide.....	7
3.1 NFC Configuration.....	7
3.2 LoRaWAN Settings.....	8
3.3 Basic Settings.....	11
3.4 Advanced Settings.....	11
3.4.1 Calibration Settings.....	11
3.4.2 Threshold Settings.....	11
3.4.3 Alarm Settings.....	12
3.5 Maintenance.....	12
3.5.1 Upgrade.....	12
3.5.2 Backup.....	13
3.5.3 Reset to Factory Default.....	14
4. Installation.....	14
5. Milesight IoT Cloud Management.....	15
6. Device Payload.....	16
6.1 Basic Information.....	17
6.2 Sensor Data.....	17
6.3 Downlink Commands.....	18

1. Product Introduction

1.1 Overview

EM300 series is a sensor mainly used for outdoor environment through wireless LoRa network. EM300 device is battery powered and designed for multiple mounting ways. It is equipped with NFC (Near Field Communication) and can easily be configured by a smartphone.

Sensor data are transmitted in real-time using standard LoRaWAN[®] protocol. LoRaWAN[®] enables encrypted radio transmissions over long distance while consuming very little power. The user can obtain sensor data and view the trend of data change through Milesight IoT Cloud or through the user's own Network Server.

1.2 Features

- Up to 11 km communication range
- Easy configuration via NFC
- Standard LoRaWAN[®] support
- Milesight IoT Cloud compliant
- Low power consumption with 4000mAh replaceable battery

2. Hardware Introduction

2.1 Packing List



1 × EM300 Sensor



Wall Mounting
Kits



1 ×
Warranty Card



1 ×
Quick Guide



Double Sided Tape(for
SLD or MCS sensor)



Mounting Screws (for
SLD or MCS sensor)



If any of the above items is missing or damaged, please contact your sales representative.

2.2 Hardware Overview

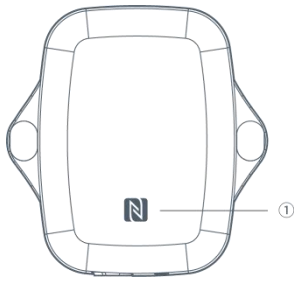

Front View:

① NFC Area

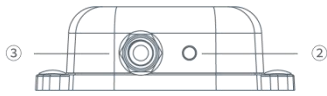

Bottom View:

② Vent

③ Waterproof Connectors

(For water leakage and magnet switch sensor)



2.3 Dimensions(mm)

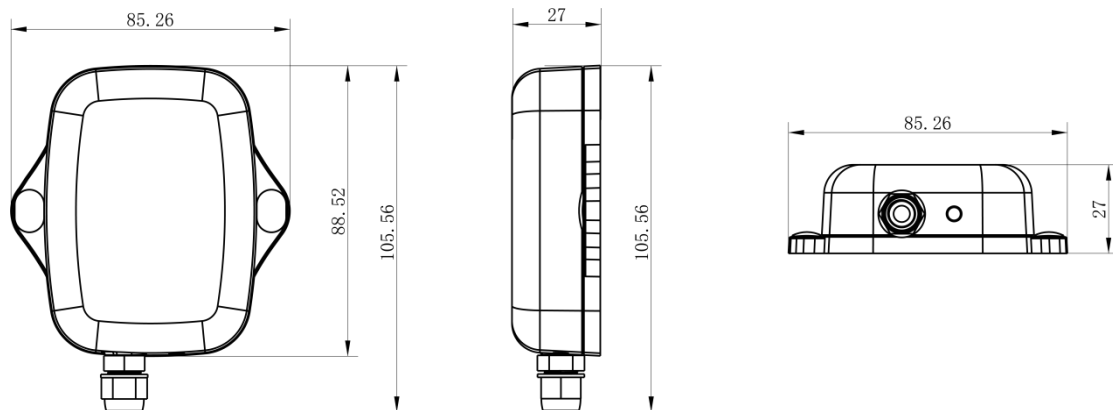

2.4 Power Button

Note: The LED indicator and power button are inside the device. Switch on/off and reset can also be configured via NFC.

Function	Action	LED Indication
Turn On	Press and hold the button for more than 3 seconds.	Off → On
Turn Off	Press and hold the button for more than 3 seconds.	On → Off
Reset	Press and hold the button for more than 10 seconds.	Blink 3 times.

Check On/Off Status	Quickly press the power button.	Light On: Device is on.
		Light Off: Device is off.

3. Operation Guide

3.1 NFC Configuration

EM300 series can be configured via NFC.

1. Download and install "Milesight ToolBox" App from Google Play or Apple Store.
2. Enable NFC on the smartphone and open "Milesight ToolBox" App.
3. Attach the smartphone with NFC area to the device to read basic information.

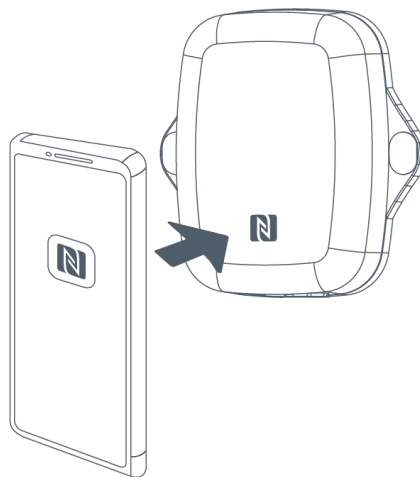

4. Basic information and settings of devices will be shown on ToolBox if it's recognized successfully. You can turn on/off the device by tapping the button on the Device Status. In order to protect the security of devices, password validation is required when configuring via unused phone . Default password is **123456**.

Status	Setting	Reset
SN	6136A39116331007	
Model	EM300-TH-915M	
Device EUI	24e124136a391163	
Firmware Version	V1.15	
Hardware Version	V2.1	
Device Status	Off	<input type="checkbox"/>

5. Tap "Read" button to check current status and sensor data of device.
6. Tap "Write" button to write all your settings to the device.

Note:

- 1) Ensure the location of smartphone NFC area and it's recommended to take off phone case.
- 2) If the smartphone fails to read/write configurations via NFC, keep the phone away and back to try again.
- 3) EM300 series can also be configured by dedicated NFC reader provided by Milesight IoT or you can configure it via TTL interface inside the device.

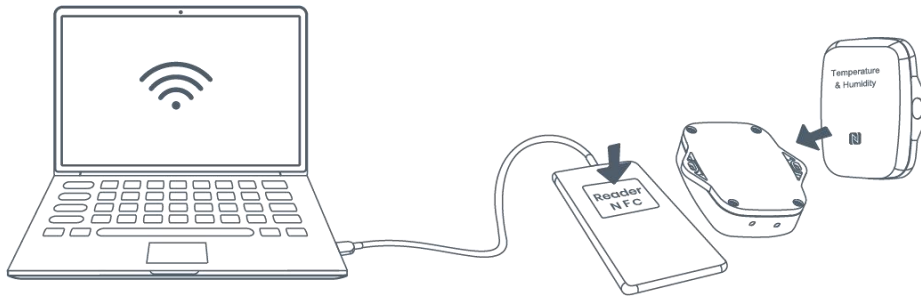

3.2 LoRaWAN Settings

LoRaWAN settings is used for configuring the transmission parameters in LoRaWAN® network.

Basic LoRaWAN Settings:

Go to **Device->Setting->LoRaWAN Settings** of ToolBox App to configure join type, App EUI, App Key and other information. You can also keep all settings by default.

Device EUI	<input type="text" value="24E124127A270222"/>
App EUI	<input type="text" value="24E124C0002A0001"/>
Application Port	<input type="text" value="85"/>
Join Type	<input type="text" value="OTAA"/>
Application Key	<input type="text" value="*****"/>
Spread Factor	<input type="text" value="SF10-DR2"/>
Confirmed Mode	<input type="checkbox"/>
Rejoin Mode	<input checked="" type="checkbox"/>
Set the number of packets sent	<input type="text" value="32"/> packets
ADR Mode	<input checked="" type="checkbox"/>

Parameters	Description
Device EUI	Unique ID of the device which can also be found on the label.
App EUI	Default App EUI is 24E124C0002A0001.
Application Port	The port used for sending and receiving data, default port is 85.
Join Type	OTAA and ABP mode are available.
Application Key	Appkey for OTAA mode, default is 5572404C696E6B4C6F52613230313823.
Device Address	DevAddr for ABP mode, default is the 5 th to 12 th digits of SN.
Network Session Key	Nwkskey for ABP mode, default is 5572404C696E6B4C6F52613230313823.
Application Session Key	Appskey for ABP mode, default is 5572404C696E6B4C6F52613230313823.
Spread Factor	If ADR is disabled, the device will send data via this spread factor.
Confirmed Mode	If the device does not receive ACK packet from network server, it will resend data 3 times at most.
Rejoin Mode	Reporting interval \leq 30 mins: device will send specific mounts of LoRaMAC packets to check connection status every 30 mins; If no reply after specific packets, the device will re-join. Reporting interval $>$ 30 mins: device will send specific mounts of LoRaMAC packets every to check connection status every reporting interval; If no reply after specific packets, the device will re-join.
ADR Mode	Allow network server to adjust datarate of the device.
Tx Power	Transmit power of device.

Note:

- 1) Please contact sales for device EUI list if there are many units.
- 2) Please contact sales if you need random App keys before purchase.
- 3) Select OTAA mode if you use Milesight IoT cloud to manage devices.
- 4) Only OTAA mode supports rejoin mode.

LoRaWAN Frequency Settings:

Go to **Setting->LoRaWAN Settings** of ToolBox App to select supported frequency and select channels to send uplinks. Make sure the channels match the LoRaWAN[®] gateway.

Basic
Channel

Support Frequency : EU868

<input type="checkbox"/>	Index	Frequency/MHz	Max Datarate	Min Datarate
<input checked="" type="checkbox"/>	0	<input style="width: 80px;" type="text" value="868.1"/>	5-SF7BW125	0-SF12BW125
<input checked="" type="checkbox"/>	1	<input style="width: 80px;" type="text" value="868.3"/>	5-SF7BW125	0-SF12BW125
<input checked="" type="checkbox"/>	2	<input style="width: 80px;" type="text" value="868.5"/>	5-SF7BW125	0-SF12BW125
<input type="checkbox"/>	3	<input style="width: 80px;" type="text" value="0"/>	5-SF7BW125	0-SF12BW125
<input type="checkbox"/>	4	<input style="width: 80px;" type="text" value="0"/>	5-SF7BW125	0-SF12BW125
<input type="checkbox"/>	5	<input style="width: 80px;" type="text" value="0"/>	5-SF7BW125	0-SF12BW125
<input type="checkbox"/>	6	<input style="width: 80px;" type="text" value="0"/>	5-SF7BW125	0-SF12BW125
<input type="checkbox"/>	7	<input style="width: 80px;" type="text" value="0"/>	5-SF7BW125	0-SF12BW125

If frequency is one of CN470/AU915/US915, you can enter the index of the channel that you want to enable in the input box, making them separated by commas.

Examples:

1, 40: Enabling Channel 1 and Channel 40

1-40: Enabling Channel 1 to Channel 40

1-40, 60: Enabling Channel 1 to Channel 40 and Channel 60

All: Enabling all channels

Null: Indicates that all channels are disabled

Support Frequency : AU915

Enabled Channel Index: 0-71

Channel Index	Frequency/MHz	Channel Spacing/MHz	BW/kHz
0 - 15	915.2 - 918.2	0.2	125
16 - 31	918.4 - 921.4	0.2	125
32 - 47	921.6 - 924.6	0.2	125
48 - 63	924.8 - 927.8	0.2	125
64 - 71	915.9 - 927.1	1.6	500

Note:

For -868M model, default frequency is EU868;

For -915M model, default frequency is AU915.

3.3 Basic Settings

Go to “**Device->Setting->General Settings**” of ToolBox App to change the reporting interval, etc.

Temperature Unit 

°C

Reporting Interval 10 min

Change Password

Parameters	Description
Reporting Interval	Reporting interval of transmitting data to network server.Default: 600s
Temperature Unit	Change the temperature unit displayed on the ToolBox. Note: 1) The temperature unit in the reporting package is fixed as °C. 2) Please modify the threshold settings if the unit is changed.
Change Password	Change the password for ToolBox App or software to read/write this device.

3.4 Advanced Settings

3.4.1 Calibration Settings

ToolBox supports numerical calibration for all items. Go to “**Device->Setting->Calibration Settings**” of ToolBox App to type the calibration value and save, the device will add the calibration value to raw value.

Temperature

Numerical Calibration

Current Value: 0 °C

Calibration Value

°C

Final Value: -1 °C

Humidity

3.4.2 Threshold Settings

Go to **Device->Setting->Threshold Settings** of ToolBox App to enable the threshold settings and

input the threshold. EM300 series will upload the current data once instantly after the temperature threshold is triggered.

Temperature

Over / °C

Below / °C

Collecting Interval 1 min

3.4.3 Alarm Settings

Go to “**Device->Setting->Alarm Settings**” of ToolBox App to enable the alarm settings. When EM300 detects door status change or water leakage, it will report the alarm according to reporting interval and reporting times setting.

Alarm Reporting

If someone invades, the alarm reporting interval and the alarm reporting times can be set as follows

Alarm Reporting Interval 1 min

Alarm Reporting Times 2

3.5 Maintenance

3.5.1 Upgrade

1. Download firmware from Milesight website to your smartphone.
2. Open Toolbox App and click “Browse” to import firmware and upgrade the device.

Note:

- 1) Operation on ToolBox is not supported during an upgrade.
- 2) Only Android version ToolBox supports the upgrade feature.

Status	Setting	Maintenance
SN	6136B26167392109	
Model	EM300-ZLD-915M	
Firmware Version	V1.1-a1	
Hardware Version	V3.0	
Manual Upgrade		

[Browse](#)



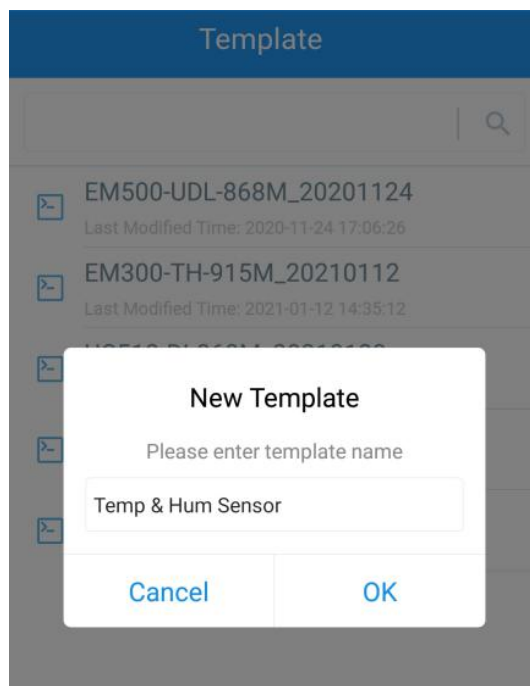

3.5.2 Backup

EM300 devices support configuration backup for easy and quick device configuration in bulk. Backup is allowed only for devices with the same model and LoRa frequency band.

1. Go to “Template” page on the App and save current settings as a template. You can also edit the template file.
2. Select one template file which saved in the smartphone and click “Write”, then attach to another device to write configuration.



Note: Slide the template item left to edit or delete the template. Click the template to edit the configurations.

Template	
 EM500-UDL-868M_20201124 Last Modified Time: 2020-11-24 17:06:26	
 EM300-TH-915M_20210112 Last Modified Time: 2021-01-12 14:35:12	
 UC512-DI-868M_20210128 Last Modified Time: 2021-01-28 16:57:20	
 UC501-470M_20210201 Last Modified Time: 2021-02-01 11:29:43	
 M_20210208 Last Modified Time: 2021-02-08 16:44:37	Edit Delete

3.5.3 Reset to Factory Default

Please select one of following methods to reset device:

Via Hardware: Hold on power button (internal) for more than 10s.

Via ToolBox App: Go to "Device->Maintenance" to click "Reset", then attach smart phone with NFC area to device to complete reset.

Status	Setting	Maintenance
SN	6136B26167392109	
Model	EM300-ZLD-915M	
Firmware Version	V1.1-a1	
Hardware Version	V3.0	
Manual Upgrade		
Browse		
Restore Factory Default		
Reset		

4. Installation

1. Attach EM300 to the wall and mark the two holes on the wall. The connecting line of two holes must be a horizontal line.

2. Drill the holes according to the marks and screw the wall plugs into the wall.
3. Mount the EM300 to the wall via mounting screws.
4. Cover the mounting screws with screw caps.

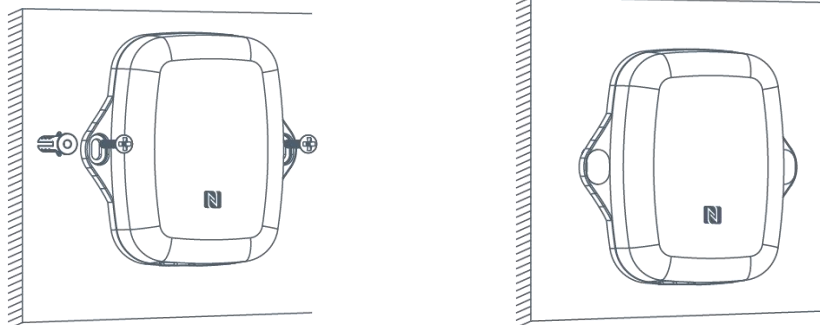

5. For leak detection sensor, install the probe/cable to the place where liquid may leak. For magnet switch sensor, install the magnet beside the door/window.

Note: For SLD sensor, please ensure the metal pins of the probe are flat on the floor; for ZLD sensor, the cable can't be twined or accumulated together. The probe or cable of water leakage sensor should be placed in an area of concern where water from a leak would likely accumulate.

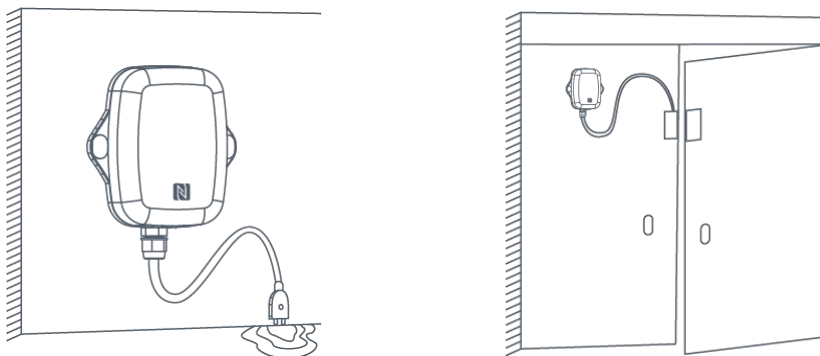

5. Milesight IoT Cloud Management

EM300 series can be managed by Milesight IoT Cloud platform. Milesight IoT cloud is a comprehensive platform that provides multiple services including device remote management and data visualization with the easiest operation procedures. Please register a Milesight IoT Cloud account before operating following steps.

1. Ensure Milesight LoRaWAN® gateway is online in Milesight IoT Cloud. For more info about connecting gateway to cloud please refer to gateway's user guide.

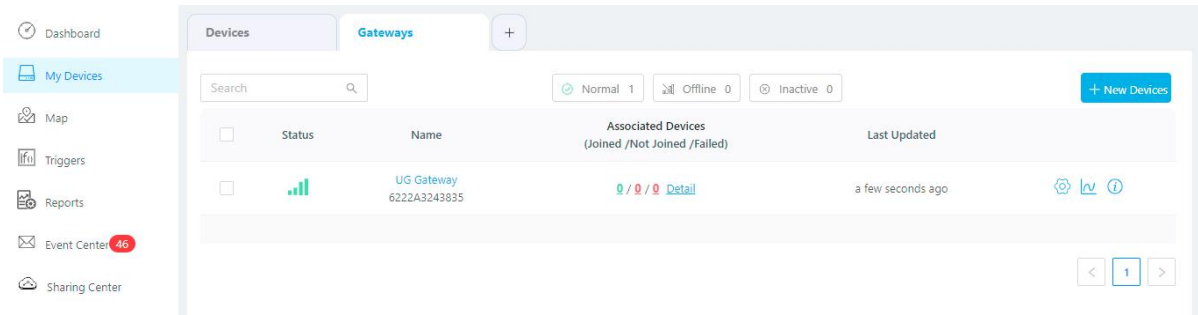

2. Go to “My Devices” page and click “+New Devices”. Fill in the SN of device and select associated gateway.

Add Device ✕

* SN:

* Name:

* Associated Gateway:

* Device EUI:

* Application Key:

3. After the device is online in Milesight IoT Cloud, you can check the data via webpage or mobile App and create dashboard for it.

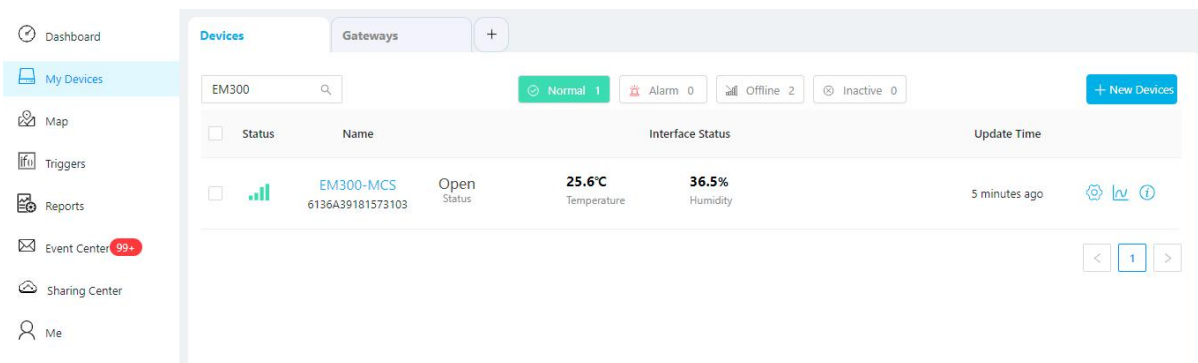

6. Device Payload

All data are based on following format(HEX):

Channel1	Type1	Data1	Channel2	Type2	Data2	Channel 3	...
1 Byte	1 Byte	N Bytes	1 Byte	1 Byte	M Bytes	1 Byte	...

For decoder examples please find files on <https://github.com/Milesight-IoT/SensorDecoders>.

6.1 Basic Information

EM300 series sensors report basic information of sensor whenever joining the network.

Channel	Type	Description
ff	01(Protocol Version)	01=>V1
	09 (Hardware Version)	01 40 => V1.4
	0a(Software Version)	01 14 => V1.14
	0f(Device Type)	00: Class A, 01: Class B, 02: Class C
	16(Device SN)	16 digits

Example:

ff 09 01 00 ff 0a 01 02 ff 0f 00					
Channel	Type	Value	Channel	Type	Value
ff	09 (Hardware version)	0100 (V1.0)	ff	0a (Software version)	0102 (V1.2)
Channel	Type	Value			
ff	0f (Device Type)	00 (Class A)			

6.2 Sensor Data

EM300 series sensors report sensor data according to reporting interval (10min by default). Battery level is reported every 6 hours.

Channel	Type	Description
01	75(Battery Level)	UINT8, Unit: %
03	67 (Temperature)	INT16, Unit: °C
04	68(Humidity)	INT8, Unit: %
05	00(Water Leakage Status)	00: Not water leakage 01: Water leakage
06	00(Magnet Status)	00: Magnet switch closed 01: Magnet switch open

Example:

01 75 64 03 67 10 01 04 68 71 05 00 01					
Channel	Type	Value	Channel	Type	Value

01	75 (Battery)	64 => 100%	03	67 (Temperature)	10 01 => 01 10 = 272 Temp=272*0.1=27.2°C
Channel	Type	Value	Channel	Type	Value
04	68 (Humidity)	71=>113 Hum=113* 0.5=56.5%	05	00	01=>Water leakage

6.3 Downlink Commands

EM300 series sensors support downlink commands to configure the device. The application port is 85 by default.

Channel	Type	Description
ff	03 (Set Reporting Interval)	2 Bytes, unit: s

Example: Set reporting interval as 20 minutes.

ff03b004		
Channel	Type	Value
ff	03 (Set Reporting Interval)	b0 04 => 04 b0 = 1200s = 20 minutes

-END-